

The image features a detailed, close-up view of a complex industrial machine, likely a pillow or duvet maker. The machinery is composed of various black and metallic components, including rollers, gears, and structural frames. The lighting is dramatic, highlighting the textures and metallic sheen of the parts. In the upper right corner, there is a semi-transparent white rectangular area containing the company logo and name. The logo consists of a stylized red 'M' followed by the word 'MERELLO' in large, bold, black capital letters. Below this, the words 'PACKAGING MACHINES' are written in a smaller, red, sans-serif font. The main title of the catalogue, 'PILLOW AND DUVET CATALOGUE', is centered in the middle of the image in large, white, bold, sans-serif capital letters.

MERELLO
PACKAGING MACHINES

PILLOW AND DUVET
CATALOGUE

Since 1994 manufacturing machinery

MERELLO is a company specialized in providing a complete solution to your packaging needs, from the design of custom components to in-house manufacturing with an efficient and professional technical service.

MERELLO brings together a team with many years of experience in the sector, who contribute to the growth, innovation and success of our clients.



MERELLO

PACKAGING MACHINES

Table of contents

Pillow packing machine	4 - 5
Pillow case machine	6 - 7
Pillow roll pack machine	8 - 9
Quilt packaging line	10 - 11
Pillow roll pack	12
Pillow press & seal	13
Pillow closing	14
Pillow stuffing	15

Visit our website
for more information



ME-305

Pillow Packing Machine

Wraps & compresses pillows and quilts in tubular film

UP TO 12 PIECES/MINUTE

The bag is automatically made from polyethylene roll of tube

Fast and easy roll change by one person

High quality bags, esthetical and tight.

Measures from 40x40cm up to 80x120cm.

High reliability: cuts by blade, double sealing and minimum waste.

Transistorized PLC control and touch screen reports the status of the machine.

Variable speed drive in all motors to extend their life.

Optional equipment: Photocell for centering logo, handle puncher, label printer, flyer attachment, stacker over box, rigid handle attachment, size auto adjustment...

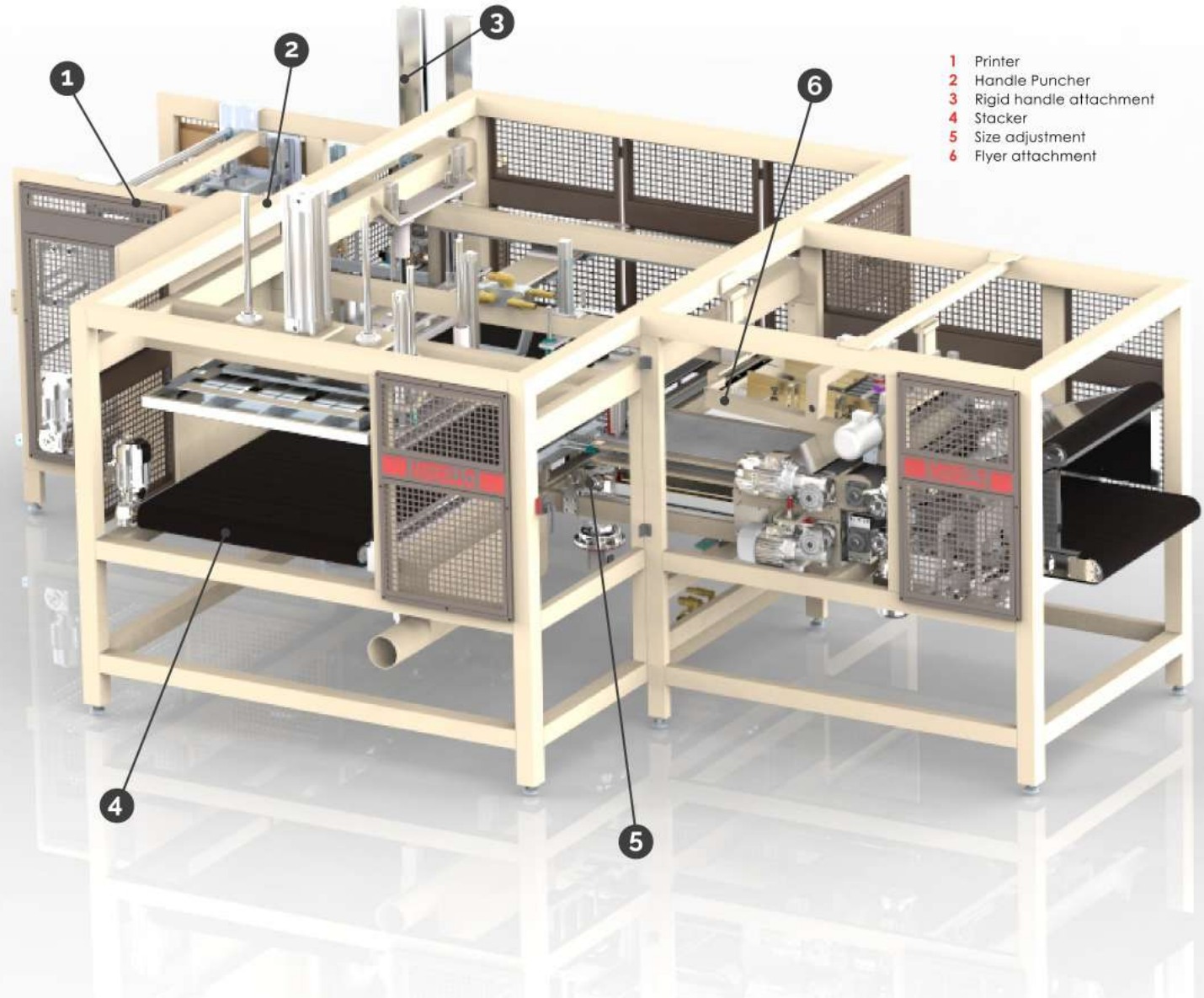
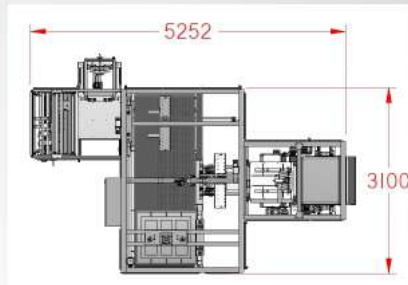

- 1 Printer
- 2 Handle Puncher
- 3 Rigid handle attachment
- 4 Stacker
- 5 Size adjustment
- 6 Flyer attachment

ME-320 Pillow Case Machine

Manufacture pillow and cushions cases from fabric rolls

UP TO 12 PILLOWS/MINUTE

Full Automatic cycle. Minimum waste, energy savings.

Pillow measures 30x30 cm to 120x80cm.

Many different materials and fabrics: TNT, cotton, polyester, quilted material...

Cuts are made with high accuracy (0.05%)

Fast and easy roll change by one person.

Transistorized PLC control and touch screen reports the status of the machine.

Variable speed drive in all motors to extend their life.

Optional equipment: blowhole sewing (now ultrasonic available), labeler device, left hand overlock, support for double infeed.

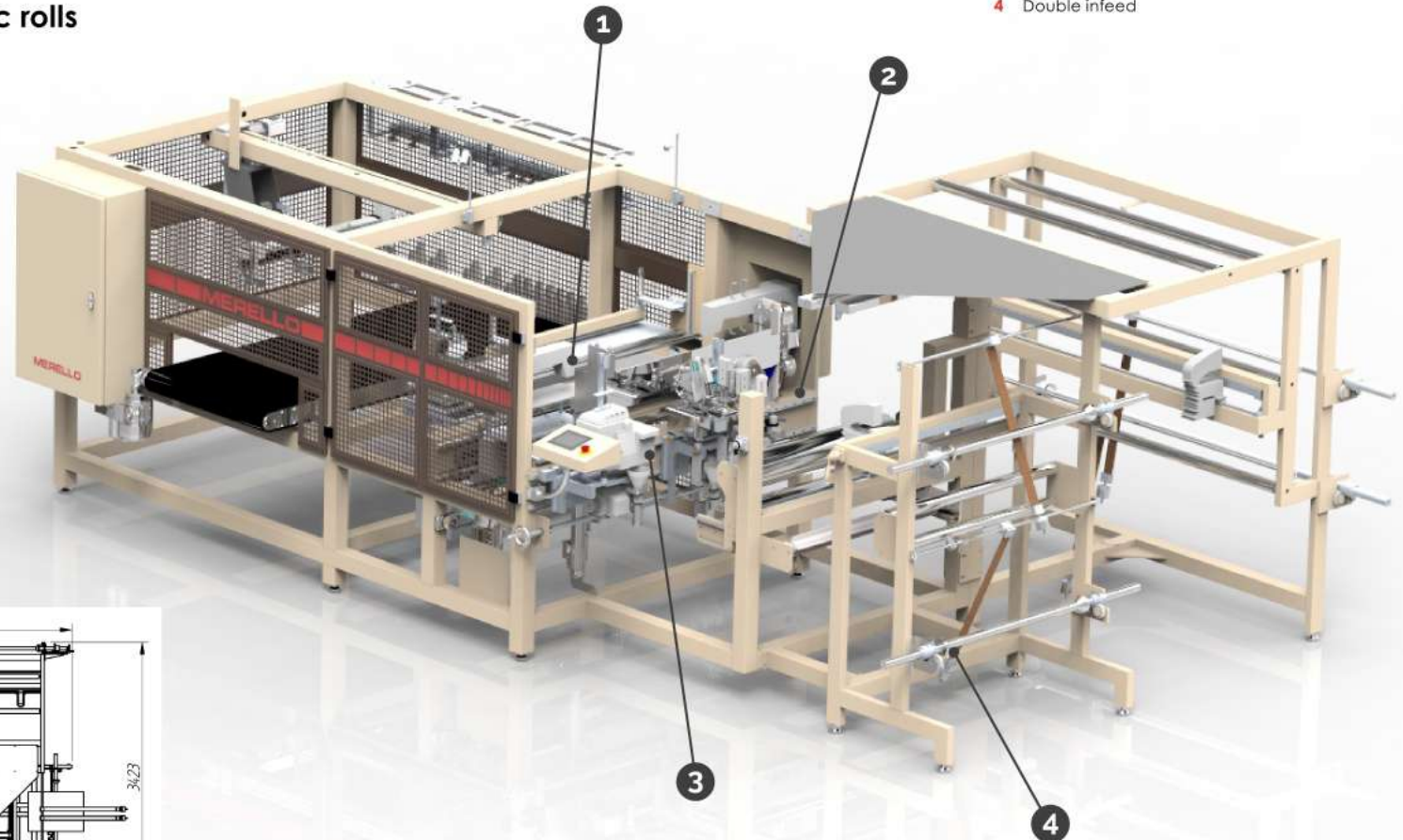
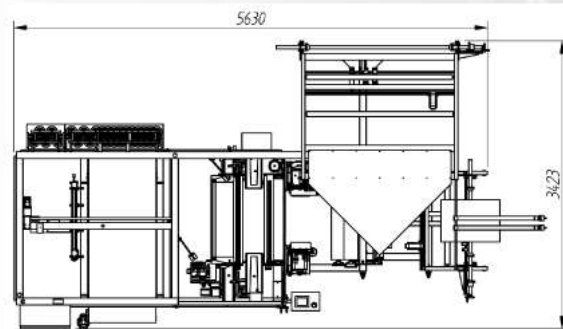

- 1 Blowhole sewing (now available in ULTRASONIC)
- 2 Label-Device
- 3 Left hand overlock
- 4 Double infeed

ME-306

Pillow Roll Pack Machine

Rolls and packs pillows and quilts in polyethylene or paper bag.

UP TO 9 PIECES/MINUTE

Full Automatic cycle: manufacture of the bag, reception, rolling, bagging and seal

Pillow measures 30x30 cm to 70x90cm.

Bag diameter from $\Phi 12$ cm to $\Phi 40$ cm

Cut is made by knife, clean and neat

Fast and easy roll change by one person.

Transistorized PLC control and touch screen reports the status of the machine.

Variable speed drive in all motors to extend their life.

Optional equipment: Photocell for centering logo, handler puncher, label printer, booklet attachment, silicon applicator

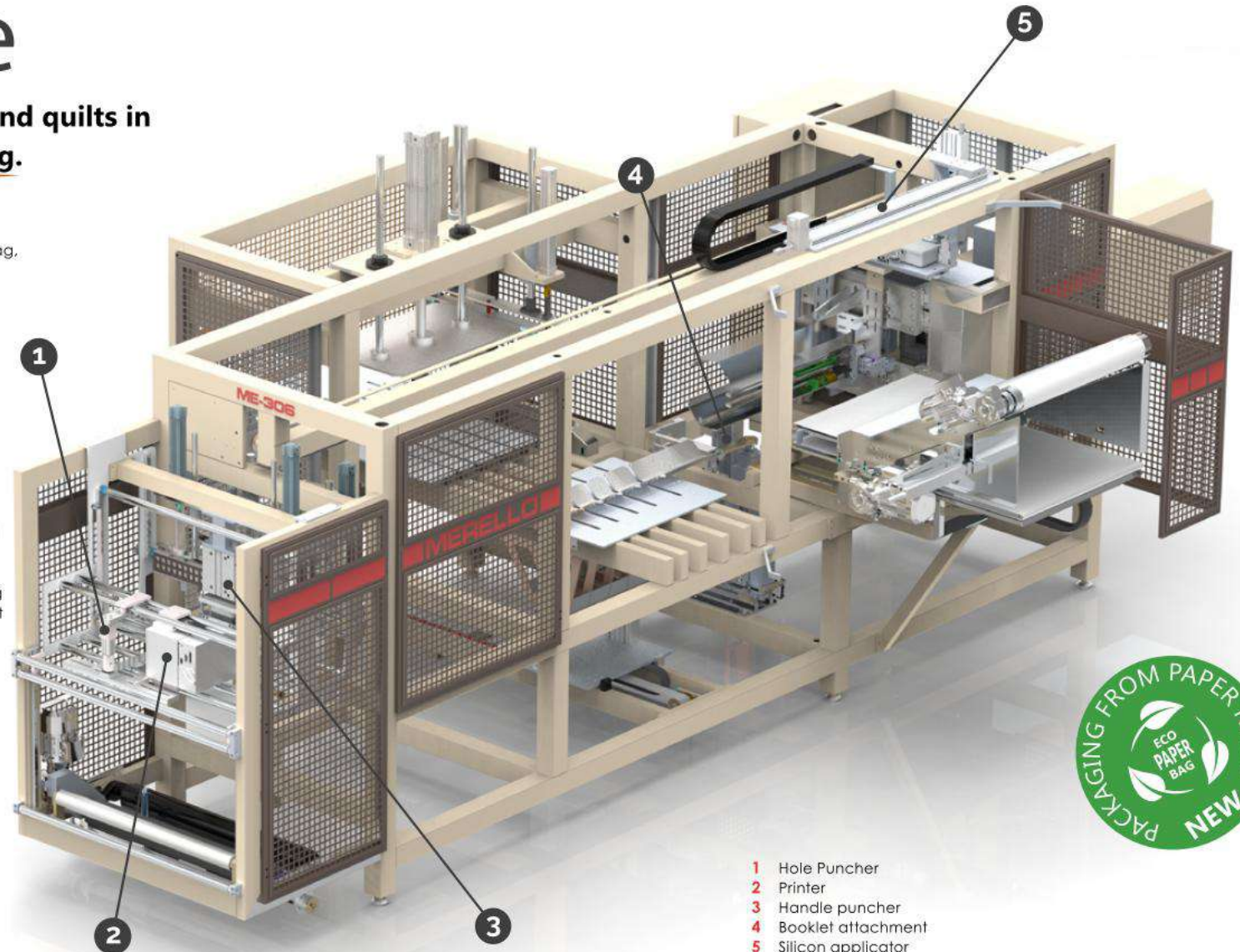
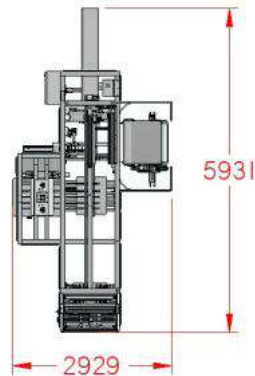

- 1 Hole Puncher
- 2 Printer
- 3 Handle puncher
- 4 Booklet attachment
- 5 Silicon applicator



ME-402 / 410

Quilt Packaging Line

Folds and packs quilts in zipper bags

UP TO 6 PIECES/MINUTE

Folds quilts, duvets and comforters, and pushes them into a zipper bag

Excellent presentation for your products: square box from 38x38x20 to 70x50x40

All movements are made by servo motor, providing maximum precision on folds

Fast and easy program change, just one touch on the screen

Transistorized PLC control and touch screen reports the status of the machine.

Optional equipment: Weighing control, infeed device, roll pack at the other side...

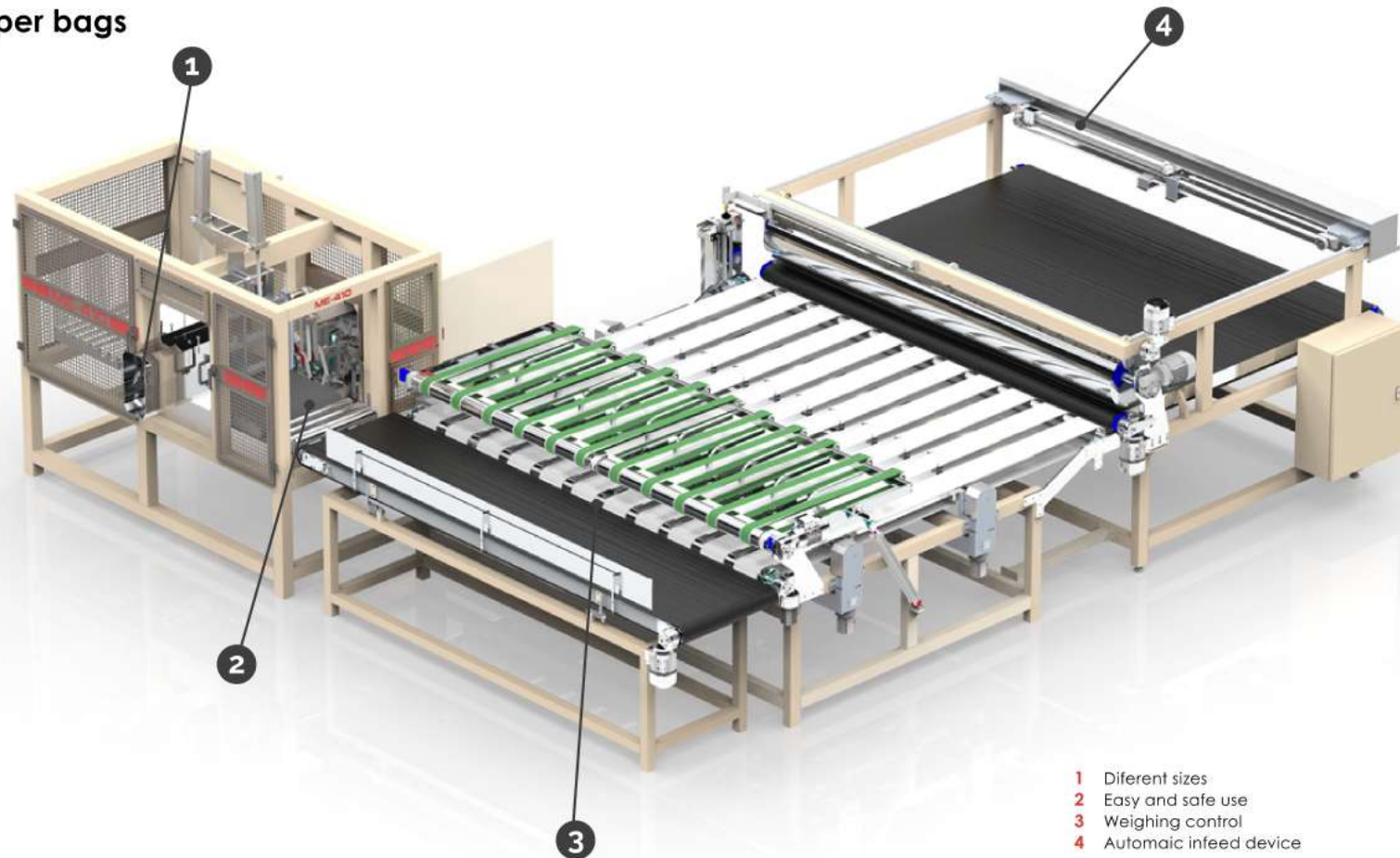
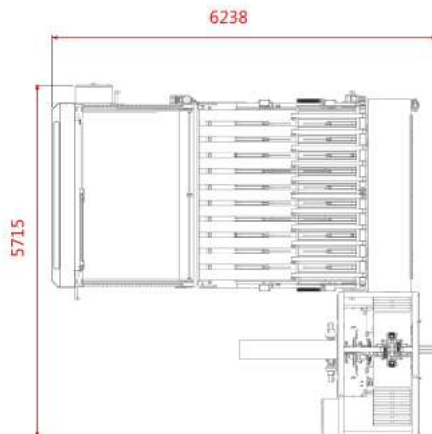

- 1 Different sizes
- 2 Easy and safe use
- 3 Weighing control
- 4 Automatic infeed device



ME-303



Pillow Roll Pack

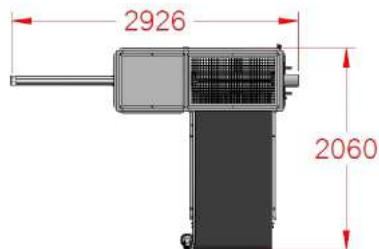

Rolls pillows and quilts and pushes into zipper bag

Output diameters: 12,15,20 cm (20,25,30 cm ExtraThick option)

Measures from 30x30 to 65x100 (80x100 cm Extra Wide option)

Up to 6 cycles per minute

ME-301



Pillow Press & Seal

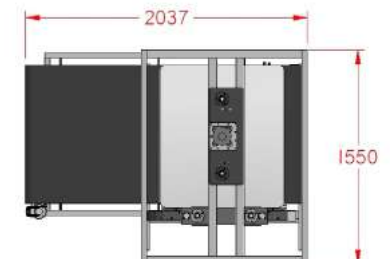

Compresses and seals bags with pillows, comforters,...

Measures up to 80x100. compression up to 1000 kgf

Cut by blade, smoke free, clean and neat termination

Up to 12 cycles per minute



ME-335

Pillow Closing

Closes the pillow by overlock with perfect sews.
Different overlock seams available

Automatic feed to the packaging system

Labeling and fiber distribution system optional

Up to 8 cycles per minute

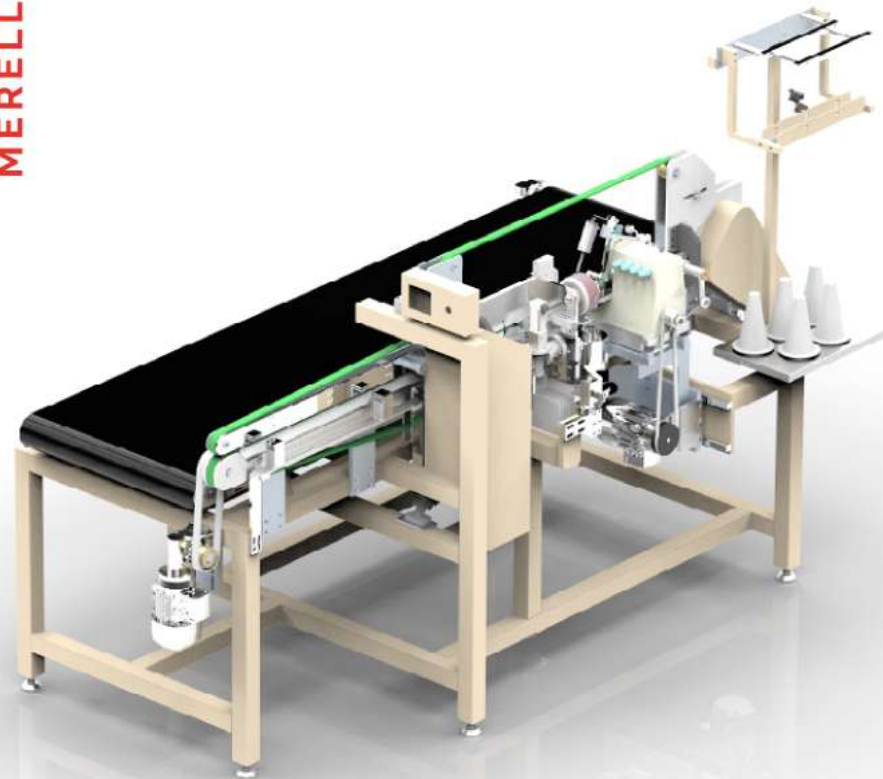
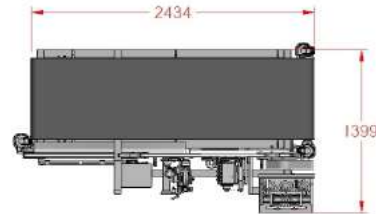

ME-304

Pillow Stuffing

Fills pillow case or bags with fiber material (quilts, pillows...)

Continuous or 'on demand' cycle

Automatic feed to the packaging system

Up to 12 cycles per minute

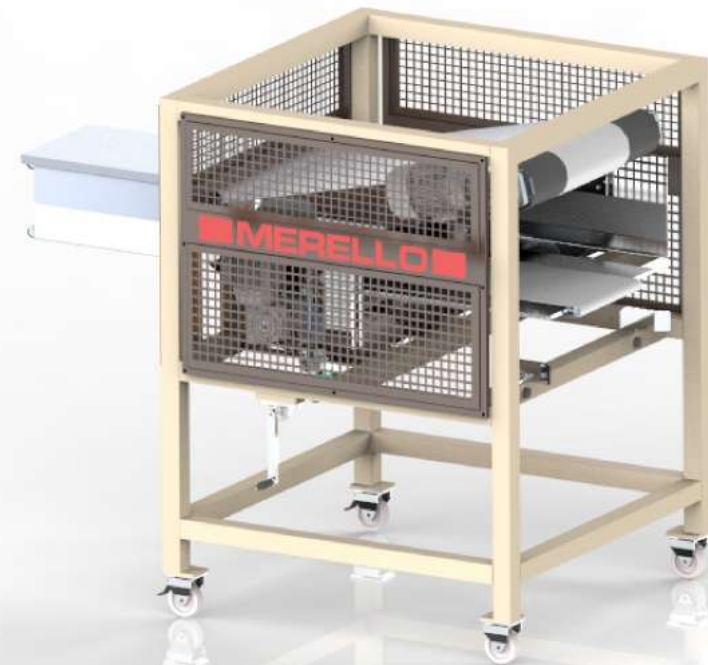
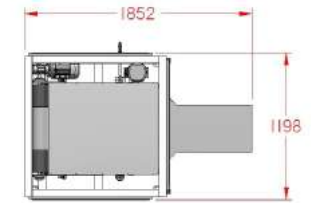



MERELLO

I N G E N I E R O S

Calle Oropéndolas, 16 (Edificio Merello)

28320 PINTO, Madrid (Spain)

Phone: +34 916 925 237

Whatsapp: +34 653 929 729

sales@merello.es

<https://merello.es>

MERELLO
INDUSTRIAL ROBOTICS

MERELLO
PACKAGING MACHINES